



design guide



www.iconselters.com
800-748-0985

Content



Featured Projects

Custom structures and notable projects



ICON Originals

- | | |
|-------------------|----------------------|
| Craftsman Series™ | Trail Series™ |
| IRONWORKS™ | American Dreamfield™ |
| Vista Series™ | En Route™ |
| LiveShade™ | ICON Ride™ |
| ICON Swings | ICON Gazebos |

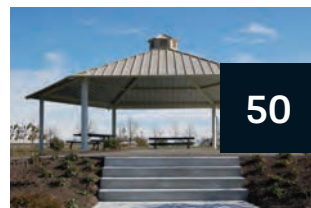

Industry Standards

- | | |
|-------------------|-----------------------|
| Squares | Intervals |
| Hexagons | Stretched Shelters |
| Octagons | Dual-Slope Shelters |
| Gabled Rectangles | Decagons & Dodecagons |
| Hipped Rectangles | Mono-Slope Shelters |
| Barrel Vaults | Mini-Shelters |

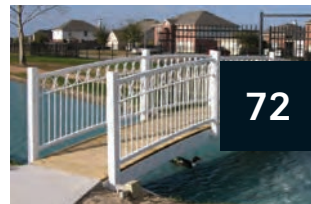

Other Structures

- | | |
|------------------------|-------------------|
| Band Shells | Mailbox Shelters |
| Partial Shade/Arbors | Clock Towers |
| Partial Shade/Solumbra | Umbrella Shelters |
| Pedestrian Bridges | Message Shelters |
| Porta-Potty Enclosures | Fabric Shades |

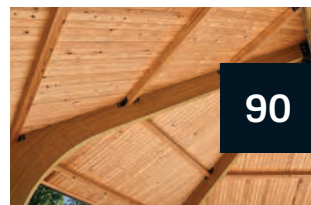

Wood Structures

- Engineered Wood Structures by ICON
- Low-Pitched Beam Shelters
 - Solid and Open Arch Shelters
 - Enclosed Buildings
 - Post-and-Beam Shelters
 - Pedestrian Bridges



Information

- Miscellaneous Information
- Options & Accessories
- Roof Deck Options
- Metal Roof Colors
- Steel Frame Finishes
- Powder Coat Colors

On The Cover



Custom AR15X54 with colored polycarbonate panels. See pgs. 6-7

Creditview Activity Hub Brampton, ON.

ICONOGRAPHY III
Collection 2020
D20001

Copyright © 2020
ICON Shelter systems Inc.

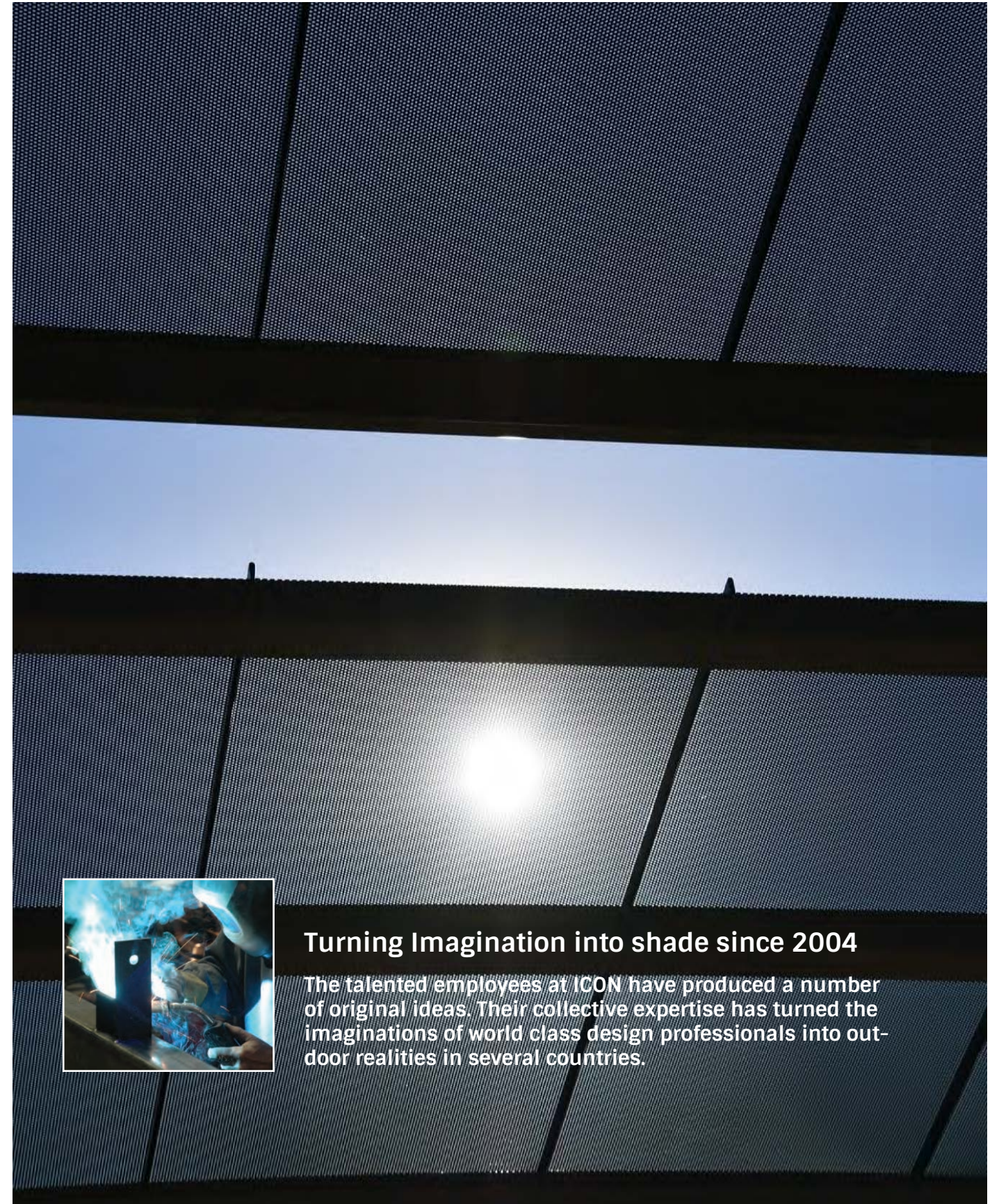

Turning Imagination into shade since 2004

The talented employees at ICON have produced a number of original ideas. Their collective expertise has turned the imaginations of world class design professionals into outdoor realities in several countries.

Creditview Activity Hub, Brampton, ON

Design: Baker Turner Inc.
Developer: City of Brampton, ON
Sales: PlayPower LT Canada, Inc.



Recently opened is the Creditview Activity Hub, an 85,000 square foot AODA compliant, fully accessible play area for children with physical, mental and emotional challenges and disabilities.

The most noticeable feature of the shade structure is the roof. Comprised of layered translucent polycarbonate in a variety of hues, the roof is an interesting mosaic that provides colorful light projections to the pavement below. The colored panels are attached to the steel frame with stainless steel stand-off hardware.

Featured Project

Civita Park, when complete, will be one of the largest public parks in metropolitan San Diego. It has been planned by Sudberry Properties under the jurisdiction of City of San Diego Public Works Department and other agencies.

Schmidt Design Group Inc. was retained to design the park based on the shared vision of the city, the public and the community planning groups. They retain design copyrights of all structures.



01



02



05



03



06



04



07

Civita Park, San Diego, CA

Design: Schmidt Design Group Inc.
 Developer: Sudberry Properties
 Sales: Unique Recreation Consultants

01 & 02 Signature Structure Band Shell 70' X 35'
 03 Living Shade Structures - six sets of 3 arches with stainless steel cable to train Wisteria
 04 Social Node Structures with stainless steel cable to train Wisteria
 05 & 06 Special Events Structure 41' X 43'
 06 Playground Picnic Shelters 33' X 19'

Gulf Coast Town Center, Ft. Myers, FL

A collaborative effort with Landscape Forms Studio 431

Design: Wantman Group, Inc. and Landscape Forms, Inc.
Developer: North American Development Group

Landscape Forms Inc. of Kalamazoo, Michigan partnered with ICON Shelter Systems Inc. to produce this attractive centerpiece in a new play space at the Gulf Coast Town Center in Ft Myers, Florida. It has two swings on one end, lighting, and misting nozzles throughout. The design cannot be reproduced without permission, and is shown to highlight ICON's fabrication capabilities.



Featured Project



A Partnership

This project was produced by ICON as an OEM supplier to Studio 431, the custom structures division of Landscape Forms Inc. of Kalamazoo, Michigan. Studio 431 works with architects, landscape architects, and industrial designers to produce high visibility custom projects.

Custom Picnic Shelter, Stapleton, CO

Design: DIG Studio Landscape Architecture
Developer: The Park Creek Metropolitan District
Construction: Mortenson Construction
Sales: Recreation Plus, Ltd

Materials

| | |
|---|---------------------------|
| A | Powder Coated Steel |
| B | Western Red Cedar Rafters |
| C | Tensioned Fabric |

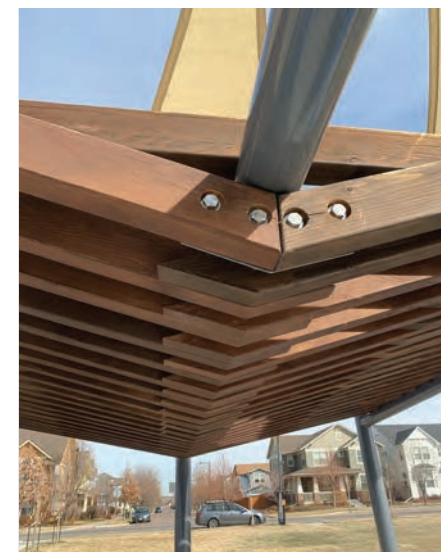

Mixed Media

There is a lot going on in this small shelter designed by DIG Studio of Denver, CO. One's eye moves from element-to-element in this mixed media composition. Steel columns support heavy Western Red Cedar wood slats, and it is all topped off with tensioned fabric to shade the picnic tables below.

In August 2016, the City of Windsor approved a request by the Rotary Club of Windsor (1918) to provide shaded seating for the Windsor Riverwalk at the Civic Terrace. The circular layout represents the Rotary wheel, deconstructed and reconstructed to symbolize the future of the organization's continued support of the community. The "Starry Night" roof panels are purposefully misaligned to suggest a future yet undecided.

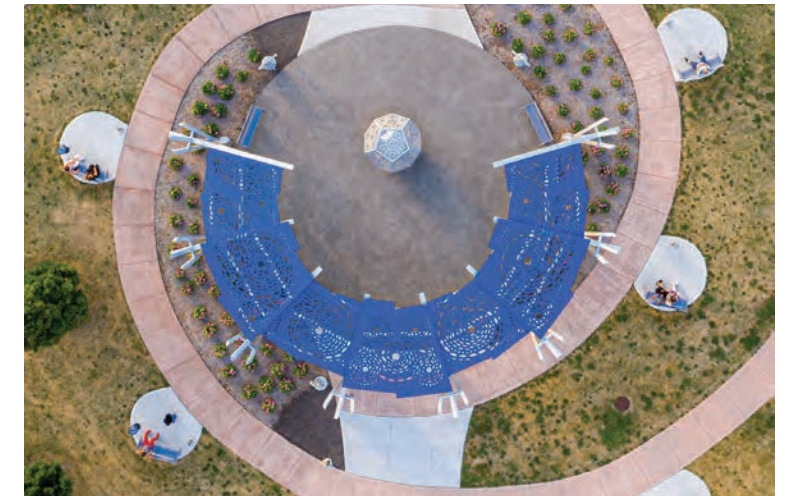

Centennial Plaza on Riverwalk, Windsor, ON

Design: Stefan Fediuk, CSLA
Developer: Rotary Club of Windsor 1918
Sales: PlayPower LT Canada, Inc.

Project designer Stefan Fediuk, said, "In honour of the First Nations who settled along the 'Bending River', the back sides of the columns form a series of tridents to symbolize the Ojibway, Ottawa and Potawatomi who make up the People of the Three Fires."

Band Shell, Celina, OH

Design: Beam Designs, LLC
Construction: Michigan Recreational Construction
Sales: DWA Recreation



Celina is a small town in western Ohio about 125 miles north of Cincinnati. A few years ago, the Celina City Council was approached with a proposal to purchase the land formerly known as Mercelina Park, and consolidate it with Lake Shore Park and Pullman Bay Park to form the Bryson Park District. The Celina City Council established a committee of community members to solicit ideas of what should be built there. The proposal that gained the most traction was the building of a new amphitheater and outdoor performance structure.

Featured Project

The band shell concept developed by Beam Design was submitted to ICON, which provided the city with a proposal to fabricate the structural members, roof deck, and the arching sign at the front of the building. The project was completed in the spring of 2019.

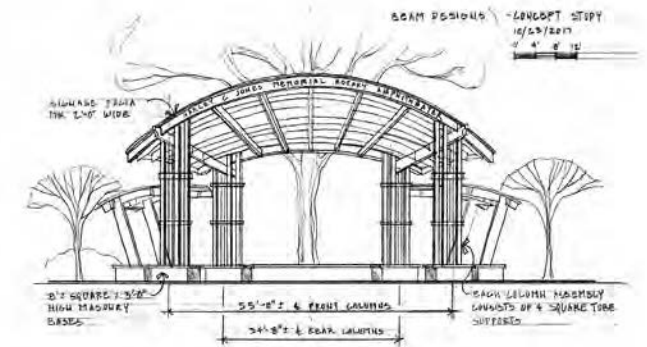

DTP - Downtown Project, Las Vegas, NV

Design: Southwick Landscape Architects
Developer: DTP
Construction: Las Vegas Paving



The Downtown Project, or DTP, was started in 2012 as a privately-funded, for-profit enterprise to revitalize sections of old downtown Las Vegas.

These free-standing cantilevered structures line the promenade on 3rd St. between Chareleston Avenue on the south and Bonneville Avenue on the north. Internal illumination increases pedestrian safety in the evening and late night hours.

Featured Project



Mission Point Resort, Mackinac Island, MI

Design: Progressive|AE
Developer: Mission Point Resort
Sales: Penchura

Part of Mission Point Resort's renovation of its outdoor promenade is this 60' square steel and fabric pavilion. Overlooking the Straits of Mackinac, it provides protected space for outdoor activities and events.

Craftsman Series™ Squares

Sizes available: Between 10' and 60'

Roof Pitch: 6/12; optional roof pitches between 3/12 and 12/12

Roof Decks: Multi-Rib, Mega-Rib, Standing Seam, 2x6 T&G

Additional roofing: Fiberglass Shingles or Sawn Cedar Shingles



01



03



02



04

- 01 CQ30M-P6, Superior, CO, Ref. No. 5003
- 02 CQ14TS-P6, Orlando, FL, Ref. No. 4086
- 03 CQ20S-P6, Omaha, NE, Ref. No. 2930
- 04 CQ34T2C-P6, Burlington, ON, Ref. No. 5195
- 05 CQ14TM-P6, Oakville, ON, Ref. No. 3030.



Craftsman Series™ Shelters

ICON designed the Craftsman Series™ in response to a request made by a landscape architecture firm in Southern California for a line of shelters that would fit into a neighborhood filled with homes built in the early decades of the 20th century.



05



01

- 01 CX30TM2C-P5, Champaign, IL, Ref. No. 5335
- 02 CX24TS-P5, Sunrise, FL, Ref. No. 2253
- 03 CX30TS-P5, Kershaw, SC, Ref. No. 5478
- 04 CX17M-P5, Maple Shade, NJ, Ref. No. 3833
- 05 CX32M-P5, Orlando, FL, Ref. No. 4581



02



03



05

Craftsman Series™ Hexagons

Sizes available: Any size up to 72'

Roof Pitch: 6/12; optional pitches between 3/12 and 12/12

Roof Decks: Multi-Rib, Mega-Rib, Standing Seam, 2x6 T&G

Additional roofing: Fiberglass Shingles or Sawn Cedar Shingles



04



Craftsman Series™ Octagons

Sizes available: Any size up to 72'

Roof Pitch: 6/12; optional pitches between 3/12 and 12/12

Roof Decks: Multi-Rib, Mega-Rib, Standing Seam, 2x6 T&G

Additional roofing: Fiberglass Shingles or Sawn Cedar Shingles



ICON Originals



- 01 CC38S2C-P4, Lancaster, CA, Ref. No. 3081
- 02 CC60TM2C-P4, Whitehouse, OH, Ref. No. 4810
- 03 CC34M2C-P4, Brick, NJ, Ref. No. 2552
- 04 CC40-10M2C-P4, Mississauga, ON, Ref. No. 3231



CRAFTSMAN SERIES

Craftsman Series™ Gables

Sizes available: Any size up to 52'

Roof Pitch: 4/12; optional pitches between 3/12 and 12/12

Roof Decks: Multi-Rib, Mega-Rib, Standing Seam, 2x6 T&G

Additional roofing: Fiberglass Shingles or Sawn Cedar Shingles

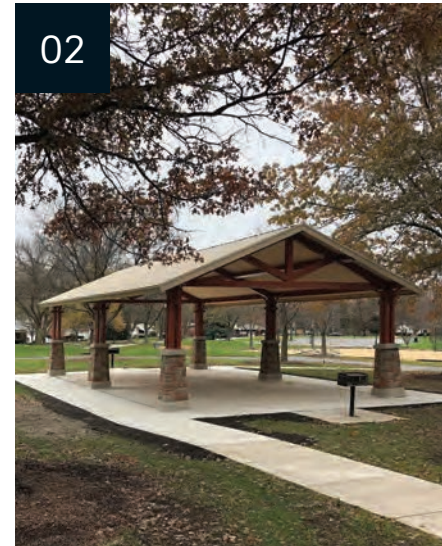

01

02

03

04

01 CG20X40TS-P4, Tinley Park, IL, Ref. No. 4404

02 CG24X44TM-P5, Darien, IL, Ref. No. 5383

03 CG26X45T-P4, Easthampton Twp, NJ, Ref. No. 4527

04 CG16X30TH-P4, San Diego, CA, Ref. No. 4265

01



Craftsman Series™ Barrel Vault

Sizes available: 12' - 52' in 3' increments
 Roof decks: Mega-Rib, 2x6 T&G
 Standard Bay Size: 20'-0"
 Roof radius: Minimum 10'-0"

- 01 CV20X30G, Hobbs, NM Ref. No. 3169
- 02 Craftsman Dutch Hip with CC4 Columns
- 03 Craftsman Dutch Hip with CC2 Columns

ICON Originals

02



03



Craftsman Series™ Dutch Hip

Sizes available: 12' - 52' in 1' increments
 Roof decks: Mult-Rib, Mega-Rib, Standing Seam, T&G
 Standard Bay Size: 20'-0"
 Roof pitch: 4/12



IRONWORKS™ Gables

IRONWORKS retro-industrial shelters and furnishings take their cue from early 20th century railroad bridges and train stations. Hidden fasteners can sometimes be over-rated, and in IRONWORKS structures they are part of the design.

IRONWORKS features : I-Beam columns with rivet plates • Architectural grade Southern Yellow Pine glu-lam rafters • 2X6 Southern Yellow Pine T&G roof deck • Rod & clevis ties or arched crossbracing • Stainless steel fasteners



01



02



03



04

01 IRG35X25TS-P8, Rockwall, TX, Ref. No. 5070. 02 IRG20X20TM-P10, Webster Grove, MO, Ref. No. 5536. 03 IRG20X24TM-P8, Bellevue, WA, Ref. No. 5417. 04 IRG 20X30TM-P10, Charlotte, NC, Ref. No. 4377. 05 IRG20X24TM-P8, Bellevue, WA, Ref. No. 5417.



05

IRG20X20 IRG20X34 IRG28X34 IRG32X34 IRG36X50 IRG40X50



IRONWORKS™

ICON Originals

01



02



03



IRONWORKS™ Alternate Designs

IRONWORKS alternate designs available in many sizes

- 01 IRONWORKS™ Two-Story Gable Shelter
- 02 IRONWORKS™ Two-column Monoslope Shelter
- 03 IRONWORKS™ Two-Column Gable Transit Shelter

IRONWORKS™ Furnishings

IRONWORKS furnishings were designed to compliment the shelters with I-beams or open channel framing and heavy wood planking.

- 04 IRONWORKS™ 6' diameter 42" high Bar with center Fire Pit and Bar Stools
- 05 IRONWORKS™ Coffee Table with 6' Bench



04



05

Vista Series™ Shelters with a View

The Vista Series™ Shelters offer shade with an elevated view. Upper levels on the larger shelters can be used for special functions, event viewing and scenic overlooks.

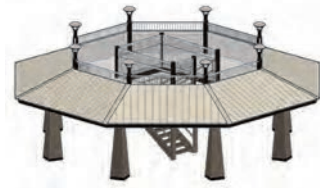

VX45M-P8
with U-turn stair



VC45M-P5
with U-turn stair

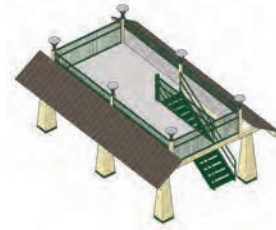

VG22X38M-P8
with straight run stair

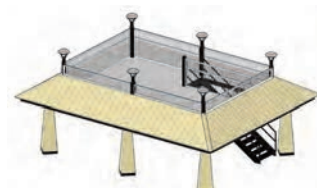

VH26X38M-P8
with straight run stair



01



02



03



Sizes available: Squares 22' - 60'
Hexagons 26' - 72'
Octagons: 26' - 72'
Rect. Gables: 22' - 50'
Rect. Hips: 22' - 50'

Roof decks: Mega-Rib, 2x6 T&G
Floor decks: 2X6 Treated, Galv. substrate (for poured concrete by others)
Standard Bay Size (rectangular): 20'-0"



04

ICON Originals



05



06

- 01 VP10X18, design only, Holland, MI
- 02 VP10X18, design only, Holland, MI
- 03 VP10X18, design only, Holland, MI
- 04 VQ22M-P8, Grapevine, TX, Ref. No. 3749
- 05 VQ22M-P8, Grapevine, TX, Ref. No. 3749
- 06 Illustration with ADA compliant walkway

01



ICON Originals

02



03



04



LiveShade™ Green Roof Shelters

Industry Standard shelters with green roof. Squares, hexagons, octagons, barrel vaults, gabled rectangles and hipped rectangles are engineered to carry the weight of a trayed plant system.

All plant materials supplied are chosen for the location of the project.

- 01 LX30TU2C-P5, Cicero, IL Ref. No. 4812
- 02 LG20X20TS2C-P4, Oakbrook Terrace, IL Ref. No. 3691
- 03 LV20X20QU, Lisle, IL Ref. No. 3235
- 04 LG24X36QU-P5, Genoa, IL Ref. No. 3284



ICON Swings!

These swing structures feature limited motion swings in all-steel or steel with wood inserts. The hinge restricts the forward to back motion to about 3' over all, and side-to-side movement is negligible. They are designed to be placed along trails and walkways but can be used anywhere seating is appropriate.

Besides these four models, ICON Swings! can be installed on most types of shelter structures.



01 The Vee Beam Swing measures 8' X 9', has two Vee columns, glue-lam timber slats and a steel swing

02 The Gable Swing is an SG6X8M-P4 with a steel swing

03 The ICON Rio Swing measures 15' X 8', has a steel frame with IPE cladding, and a steel/IPE swing

04 The Kokomo Swing measures 18' X 10' in two bays, has an inverted curved roof and two steel swings

Trail Series™ Shelters

Trail Series™ shelters are designed as a low cost solution for trails and walkways.

05

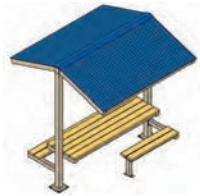

01



03



02



04



01 Trail Series™ Gable Shelters. 02 Trail Series™ Single-Post Square Shelters. 03 Trail Series™ Square Shelters. 04 Trail Series™ Mono-slope Shelters. 05 Options for two-column Trail Series™ Shelters. 06 TSG8Y-P4, Ref. No. 3722 .



06

| | | | | | | | |
|-------------|------------------|------------|-------------|------------|--------------|----------------|----------------|
| | | | | | | | |
| Ash Gray | Autumn Red | Charcoal | Clay | Ivory | Evergreen | Galvalume Plus | Hartford Green |
| | | | | | | | |
| Light Stone | Patrician Bronze | Brandywine | Regal White | Roman Blue | Surrey Beige | Terratone | Tudor Brown |
| | | | | | | | |
| Matte Black | | | | | | | |

American Dreamfield™ Athletic Field Structures

Structures for athletic fields and ball parks

- 01 MC30.5X83M-P3, Round Rock, TX, Ref. No. 4814
- 02 MT29X106M-P3, Round Rock, TX, Ref. No. 2656
- 03 MC9X84S-P2, St. Louis, MO, Ref. No. 3447
- 04 MP24X50M-P3, Ft Myers, FL, Ref. No. 2206
- 05 MC12X35M-P2, Kearney, NE, Ref. No. 4924
- 06 MP8X30TM-P3, Round Rock, TX, Ref. No. 2061
- 07 MC10X34M-P3, Glendale Heights, IL, Ref. No. 2750
- 08 SQ24TS2C-P8, Holland, MI, Ref. No. 1824
- 09 SQ12M-P4, Round Rock, TX, Ref. No. 2062
- 10 AR12.5X50.5K, Round Rock, TX, Ref. No. 4819
- 11 SQ12M-P4, Round Rock, TX, Ref. No. 4817



01



02



04



03



05



06



07



08



09



10



11

AMERICAN DREAMFIELD

Athletic Field Structures for Schools, Municipalities and Clubs

En Route™ Passenger Waiting Shelters

Custom terminal and passenger waiting shelters for transit systems



01



04



06



02



03



05



07

- 01 UB8X16G, Glendale, CO, Ref. No. 3338
- 02 US7X12G, Culowhee, NC, Ref. No. 2661
- 03 RG9X20PS-P19, Kansas City, MO, Ref. No. 2400
- 04 HX23S3C-P8, Canby, OR, Ref. No. 1890
- 05 RG20X44PS-P19, Kansas City, MO, Ref. No. 2401
- 06 UG5X9S-P12, Black Hawk, CO, Ref. No. 2352
- 07 BV5X15, Paola, KS, Ref. No. 4045

01



ICON Ride™ Cycling Shelters

Shelters, enclosed structures and accessories for the cycling enthusiast



- 01 RH11X40M2C-P4, Chicago, IL Ref. No. 4308
- 02 SG15.5X37.8M-P4, Clovis, CA Ref. No. 4251
- 03 Bicycle Garage & Waiting Shelter, Ref. No. F0007
- 04 Horizontal Bike Rack, Ref. No. F0020

02



03



04



ICON Original Gazebos

These gazebo designs came from ICON designers when the company first started. The Newport was ICON's very first shelter designed for a trade show exhibit. The Mystic was based on a 100 year-old gazebo in Mystic, Connecticut.

- 01 NP18M-P10, Orland Park, IL, Ref. No. 2300
- 02 CY16S-P6/8, Ottawa, ON, Ref. No.2821
- 03 CM20M-P10, Union, KY, Ref. No. 2396
- 04 MY24T-P4/10, Myrtle Beach, SC, Ref. No. 2302



01



02



03



04

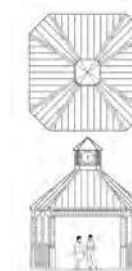

Newport Gazebo
 Sizes available: 12' - 36'
 Roof Pitch: 10/12 or 8/12
 Roof: Multi-Rib, Mega-Rib,
 Standing Seam, 2x6 T&G

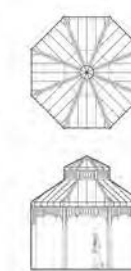

Courtyard Gazebo
 Sizes available: 16' - 60'
 Roof Pitch: 8/12 & 6/12
 Roof: Multi-Rib, Mega-Rib,
 Standing Seam, 2x6 T&G

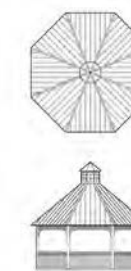

Camden Gazebo
 Sizes available: 12' - 36'
 Roof Pitch: 10/12 or 8/12
 Roof: Multi-Rib, Mega-Rib,
 Standing Seam, 2x6 T&G

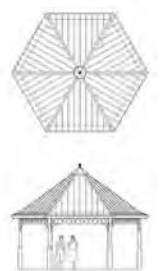

Mystic Gazebo
 Sizes available: 16' - 48'
 Roof Pitch: 8/12 & 6/12
 Roof: Multi-Rib, Mega-Rib,
 Standing Seam, 2x6 T&G

Squares

Sizes available: 12' to 60'

Roof pitch: 6/12; optional pitches between 4/12 and 12/12

Roof decks: Multi-Rib, Mega-Rib, Standing Seam, 2x6 T&G

Additional roofing: Fiberglass Shingles or Sawn Cedar Shingles



01



02

01 SQ20M-P6, Mapleton, Co, Ref. No.4326

02 SQ30M-P6, Arvada, CO, Ref. No. 5010

03 SQ24G-P6, Phoenix, AZ, Ref. No. 5208

Industry Standards



Industry Standards

These shelter structures are commonly found in the pre-engineered, manufactured shelter industry. ICON began offering these shelters in one foot increments back when other manufacturers had standard sizes in four foot increments with added costs for producing an off-sized shelter.

As with most ICON structures, you can have any size you want up to the largest size offered for the given shelter type.

03

Hexagons

Sizes available: 12' to 60'

Roof pitch: 6/12 with optional roof pitches between 4/12 and 12/12

Roof decks: Multi-Rib, Mega-Rib, Standing Seam, 2x6 T&G

Additional roofing: Fiberglass Shingles or Sawn Cedar Shingles

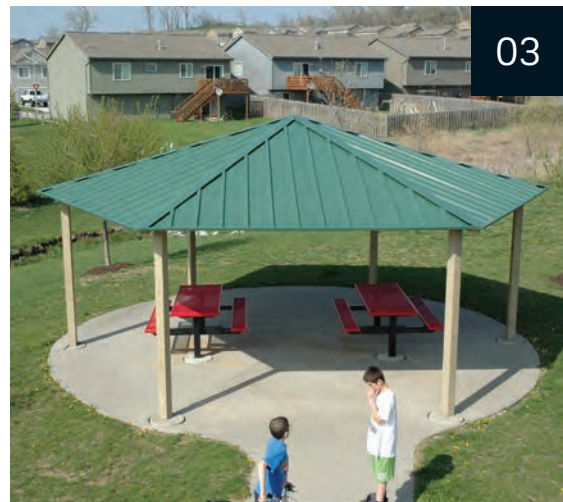

01 HX39S-P4, Tulare, CA, Ref. No. 2807. **02** HX31TM2C-P8, Decatur, IL, Ref. No. 2810. **03** HX27M-P4, Omaha, NE, Ref. No. 1800. **04** HX40M-P5, Round Lake Beach, IL, Ref. No. 2673. **05** HX27M2C-P8, Estero, FL, Ref. No. 1762

Industry Standards



01



Octagons

Sizes available: 16' - 72'

Roof pitch: 6/12 with optional pitches between 3/12 and 12/12

Roof decks: Mega-Rib, Multi-Rib, Standing Seam, 2x6 T&G

Additional roofing: Fiberglass Shingles or Sawn Cedar Shingles

01 OC28TY4V-P5, Joshua Tree, CA Ref. No. 6510

02 OC16TM-P8, Spokane, WA, Ref. No. 4612

03 OC24M2C-P6, St. Johns, NF, Ref. No. 4739

04 OC20TM-P6, New Lenox, IL, Ref. No. 2390

Industry Standards

02



03



04





01

- 01 GP30X34T-P8, Marion, IA Ref. No. 5854
- 02 GP34.8X34.8S-P4, Brampton, ON, Ref. No. 4742
- 03 RG15X20-9M-P12, Burt Lake, MI, Ref. No. 3313
- 04 RG30X84-9TM-P4, Caledonia, MI, Ref. No. 6095
- 05 RG32X44-10TS-P6, Portage, MI, Ref. No. 5539



02



04



03



05

Gabled Rectangles

Sizes available: 16' - 72'
 Standard bay spacing: 20'-0"
 Roof pitch: 4/12; optional pitches between 5/12 and 12/12
 Roof decks: Mega-Rib, Multi-Rib, Standing Seam, 2x6 T&G
 Additional roofing: Fiberglass Shingles or Sawn Cedar Shingles

Hipped Rectangles

Sizes available: 16' - 72'

Standard bay spacing: 20'-0"

Roof pitch: 4/12; optional pitches between 5/12 and 12/12

Roof decks: Mega-Rib, Multi-Rib, Standing Seam, 2x6 T&G

Additional roofing: Fiberglass Shingles or Sawn Cedar Shingles



01 RH23X43M-P4, Port Charlotte, FL, Ref. No. 6237

02 RH20X24M-P4, Tuscon, AZ, Ref. No. 4731

03 RH20X40M-P4, Colorado Springs, CO, Ref. No. 4094

04 RH30X84TS2C-P5, Punta Gorda, FL, Ref. No. 2770

Industry Standards



Barrel Vaults

Sizes available: 16' - 52' in 3' increments
 Standard bay spacing: 20'-0"
 Standard roof radius: 10'-0'
 Roof decks: Mega-Rib, 2x6 T&G



01

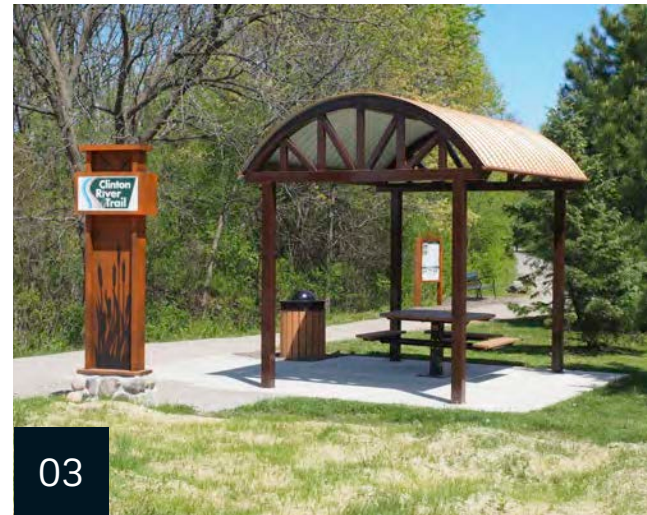

03



02



04

01 BV25X36G, Albuquerque, NM, Ref. No. 2431. 02 BV30X60G2C, Jenks, OK, Ref. No. 2001. 03 BV10X12G, Mt. Pleasant, MI, Ref. No. 4768. 04 BV20X21G, Henderson, NV, Ref. No. 4291. 05 BV18X39G, Elk Grove, CA, Ref. No. 5240



05

01



Intervals

Sizes available: 12' - 40'
 Roof pitch: 8/12 to 12/12
 Roof decks: Mega-Rib, Multi-Rib, Standing Seam, 2x6 T&G
 Additional roofing: Fiberglass Shingles or Sawn Cedar Shingles

- 01 IN29X29M-P12, Crown Point, IN, Ref. No. 4090
- 02 IN34X48M-P12, Corona, CA, Ref. No. 3455
- 03 IN16X28S-P10, Brownsburg, IN, Ref. No. 4595
- 04 IN18X18T-P10, Lucerne, CA, Ref. No. 3357

Industry Standards

02



03



04





01

01 SX30X44PS2C-P5, Wichita, KS, Ref. No. 3443
 02 SX30X44TA2C-P5, Omaha, NE, Ref. No. 3724



02

Stretched Shelters

Sizes available: 16' - 72'
 Standard bay spacing: 20'-0"
 Roof pitch: 4/12; optional pitches 5/12 to 12/12
 Roof decks: Mega-Rib, Multi-Rib, Standing Seam, 2x6 T&G
 Additional roofing: Fiberglass Shingles or Sawn Cedar Shingles



01



02



03



04

Dual-Slope Shelters

Sizes available: 16' - 72'
 Standard bay spacing: 20'-0"
 Roof pitch: 4/12; optional pitches 5/12 to 12/12
 Roof decks: Mega-Rib, Multi-Rib, Standing Seam, 2x6 T&G
 Additional roofing: Fiberglass Shingles or Sawn Cedar Shingles

01 DS20X20M-P64, Omaha, NE, Ref. No. 1799. 02 DS20X20M-P64, Aurora, CO Ref. No. 5268
 03 DS30X34M-P108, Boise, ID, Ref. No. 4533. 04 SG14X12M-P53, Venice, FL, Ref. No. 4653

Decagons and Dodecagons

Sizes available: 40' - 108'

Roof pitch: 6/12; optional pitches between 5/12 and 12/12

Roof decks: Mega-Rib, Multi-Rib, Standing Seam, 2x6 T&G

Additional roofing: Fiberglass Shingles or Sawn Cedar Shingles



01 D065M2C-P6, Santa Clara, CA, Ref. No. 2048
02 DE85-12P-P6, Cleveland, OH, Ref. No. 4108
03 D049M2C-P6, Westfield, MA, Ref. No. 2032
04 D0100P2C-P5, Brookfield, IL Ref. No. 2097

01



02



03



04

Mono-slopes

Sizes available: 16' - 52' in 1' increments
 Maximum bay spacing: 20'-0"
 Roof pitch: 4/12; optional pitches 3/12 to 8/12
 Minimum roof radius (curved roof): 10'-0"
 Roof decks-flat roof: Multi-Rib, Mega-Rib, Standing Seam, 2x6 T&G
 Roof deck-curved roof: Mega-Rib



01



03



02



04

- 01 MP32X40-9TM-P2, Oakville, ON, Ref. No. 6238
- 02 MC15X22M-P3, El Paso, TX, Ref. No. 4177
- 03 MP12X12TM-P2, Orland Park, IL, Ref. No. 5622
- 04 MP22X32M-P2.5, Beverly Hills, MI, Ref. No. 3089
- 05 BV7X13.5-P5, Rancho Cordova, Ref. No. 5633



05

01



Mini-Shelters

Sizes available: 8' - 12'

Roof pitch: 4/12; optional pitches 5/12 to 12/12

Roof decks: Mega-Rib, Multi-Rib, Standing Seam, 2x6 T&G

Additional roofing: Fiberglass Shingles or Sawn Cedar Shingles

Industry Standards

02



03



01 SH12M-P6, Clayton, CA Ref. No. 2676

02 SG10M-P4, Cape Coral, FL Ref. No. 1989

03 SG12M-P4, Carmel, ME Ref. No. 1766

Band Shells

Sizes available: 20' to 70'

Roof Pitch: roof pitches vary between 3/12 and 12/12; curved roofs

Roof Decks: Multi-Rib, Mega-Rib, Standing Seam, 2x6 T&G

Additional roofing: Fiberglass Shingles or Sawn Cedar Shingles



01



03



02



04



05



06



07

- 01 RG30X25PM-P4, Ottawa, ON, Ref. No. 4302. 02 TBV40X27-10TG, Naperville, IL, Ref. No. 6287
- 03 BX48TM-P5, Caledonia, MI, Ref. No. 6094. 04 TBV40X27-10TG, Naperville, IL, Ref. No. 6287
- 05 BV32X32TG-P4, Hewitt, TX, Ref. No. 4515. 06 BV70X52.5TG-P5, Celina, OH, Ref. No. 5639.
- 07 Custom Band Shell, San Diego, CA, Ref. No. 4702 (Design Copyright©2016 Schmidt Design Group)

Partial Shade/Arbors

Beyond your basic garden arbor. These structures can be all steel, all wood, or combination of both. Fabric shades can be integrated into the design as well.

- 01 AS22X63-12K, Madera, CA, Ref. No. 6143
- 02 AT12X80K, East Lansing, MI, Ref. No. 5068
- 03 AR14X54K, Markham, ON, Ref. No. 4530
- 04 AC28X34K2C, Oackdale, CA, Ref. No. 5215



01



02



03



04

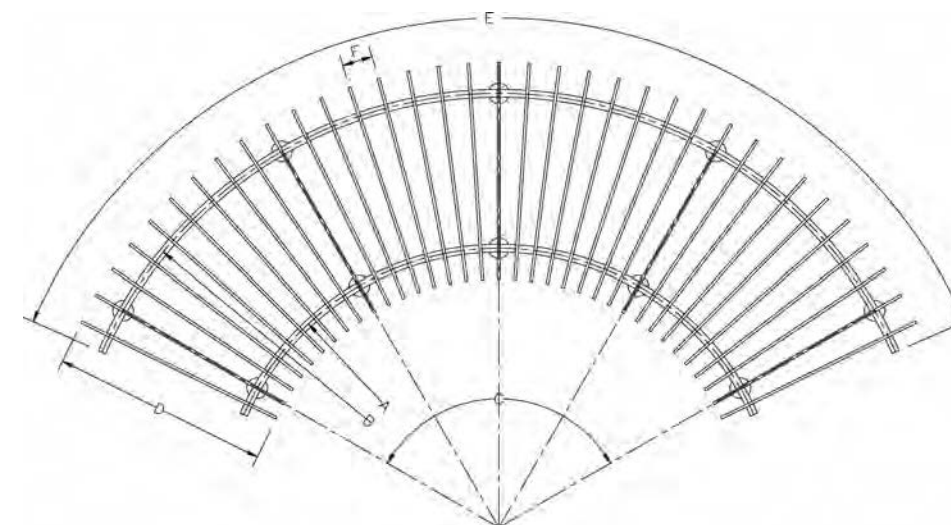

When specifying a curved arbor, please provide the dimensions shown in the illustration at left. The radii are the layout arcs of the columns.

- A. Front column layout
- B. Rear column layout
- C. Layout angle
- D. Length of slats
- E. Longest arc length
- F. Slat spacing

Partial Shade/Solumbra

Unique shadows are cast onto the pavement below the Solumbra™ shelter. The roof panels are custom designed, laser-cut and powder coated for attachment to any shelter.



- 01 FAS 12X40Z, Piscataway Twp, NJ, Ref No. 6400.
- 02 AC14X37.5K, Orland Park, IL, Ref. No. 5623.
- 03 AR6.66X44.5-8.5K, Ft. Collins, CO, Ref. No. 6108.
- 04 MC12X22Z, Orland Park, IL, Ref. No. 5625.

Other Structures



Entry Arches

Sizes available: 8' to 30'

Arch pitch: Flat to 12/12

Options and accessories: Curved arches, laser-cut medallions, color vinyl medallions, custom laser-cut arches, laser-cut lettering, custom shapes and sizes



01



03



02



04

01 EA11, Williams, CA, Ref. No. 2746. 02 RG10.5X22TA-P4, Lindenhurst, IL, Ref. No. 4368.
03 EA10, Orland Park, IL, Ref. No. 2301 04 EA10-P12, Elizabeth, NJ, Ref. No. 5114. 05
EA27-13-PO, Tracy, CA, Ref. No. 4970. 06 EA12, Glenview, IL, Ref. No. 4782. 07 Entry
Portal, Erie, CO, Ref. No. 5302.

Other Structures



05



06



07

01



Pedestrian Bridges

Girder Bridges and Truss Bridges are available in widths from 4' to 8' wide, and lengths up to 60' in length. Handrails for girder bridges can be selected from the options on page 103.

Other Structures

02



03



04



01 BR6X30, Sacramento, CA, Ref. No. 2481

02 BR4X16, Storm Lake, IA, Ref. No. 2120

03 BG4X25, Porter, TX, Ref. No. 2838

04 BR8X50, Washington, UT, Ref. No. 2415



Porta-Potty Enclosures

Sizes available: 16' - 72'
 Standard bay spacing: 20'-0"
 Roof pitch: 4/12 with optional roof pitches 5/12 to 12/12
 Roof decks: Mega-Rib, Multi-Rib, Standing Seam, 2x6 T&G
 Additional roofing: Fiberglass Shingles or Sawn Cedar Shingles

Other Structures



Mailbox Shelters

Sizes available: 16' - 72'
 Standard bay spacing: 20'-0"
 Roof pitch: 4/12 with optional roof pitches 5/12 to 12/12
 Roof decks: Mega-Rib, Multi-Rib, Standing Seam, 2x6 T&G
 Additional roofing: Fiberglass Shingles or Sawn Cedar Shingles

- | | |
|--|---------------|
| 01 RG10X10M-P4, Wildgrass, CO, | Ref. No. 4660 |
| 02 SQ30TM-P4, West Fargo, ND, | Ref. No. 4043 |
| 03 RG30X44S2C-P4, Buda, TX, | Ref. No. 3336 |
| 04 RH14X24T-P4, Myrtle Beach, NC, | Ref. No. 2669 |
| 05 RG8X8M-P9, Havelock, NC, | Ref. No. 2997 |

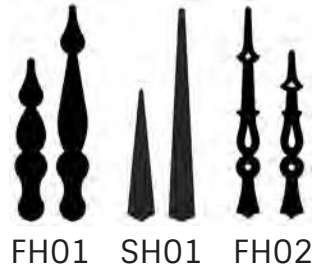

Public Time

Clock sizes: 24", 30", 36", 42", 48", 60", 72"
 Illumination: Back-lit or non-illuminated
 Time control: Automatic synchronization with or without GPS control
 Power: 120V/220V AC or 7-year Lithium Battery (for non-illuminated clocks only)



- 01 TH7M-P12, Oakwood, GA, Ref. No. 2241.
- 02 PC4 with 4 clocks.
- 03 TH8S2C-P4, Piscataway NJ, Ref. No. 2510.
- 04 PC3 with double-sided clock
- 05 TH8-19S-P8, Tracy, CA, Ref. No. 4965.
- 06 TH5-10M-P8, Portage, MI Ref. No. 5821.
- 07 TH12Z-P10, Wheeling, IL, Ref. No. 3812.



Other Structures

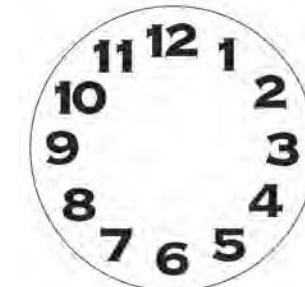

AF01



AF02

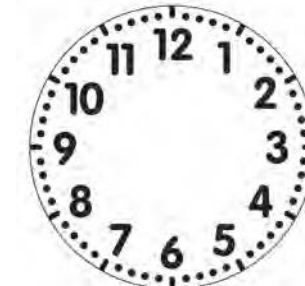

AF03



AF04

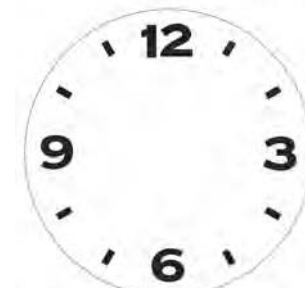

AF05



RF01

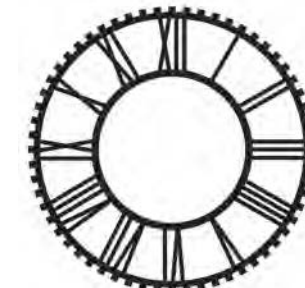

RF02

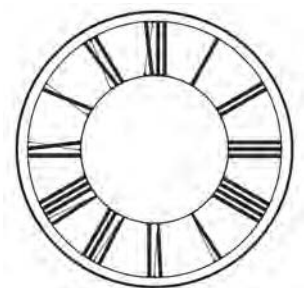

RF03



01

Message Shelters

Sizes available: 4' - 8' in 1' increments
 Roof pitches: between 3/12 and 6/12
 Roof decks: Mega-Rib, Multi-Rib, Standing Seam, 2x6 T&G
 Additional roofing: Fiberglass Shingles or Sawn Cedar Shingles



02



04



03



05

Umbrella Shelters

Sizes available: 8' - 30' in 1' increments
 Roof pitch: 6/12 with optional pitches between 3/12 and 5/12
 Roof decks: Mega-Rib, Multi-Rib, Standing Seam, 2x6 T&G
 Additional roofing: Fiberglass Shingles or Sawn Cedar Shingles

01 UM16TM-P6, Paris, ON, Ref. No. 4735. 02 RH5X10S-P4, Santee, CA, Ref. No. 4485. 03 TO5.6T-P6, Grand Haven, MI, Ref. No. 3401. 04 SG6X9T-P6, Grand Haven, MI, Ref. No. 3294. 05 Sign Display, Brick, NJ, Ref. No. 3852.

01



Fabric Shades

ICON produces rectangular, square hexagonal and octagonal fabric shelters, shade sails, and custom structures using a combination of materials to achieve the design intent.

01 HX71 Fabric Share, San Jose, CA Ref. No. 5915

02 CUS22X33Z, Aurora, CO, Ref. No. 5094

03 Fabric Shelter, Paola, KS, Ref. No. 5711

04 SQ60Z2C-P4, Mackinac Island, MI, Ref. No. 6502

Other Structures

02



03

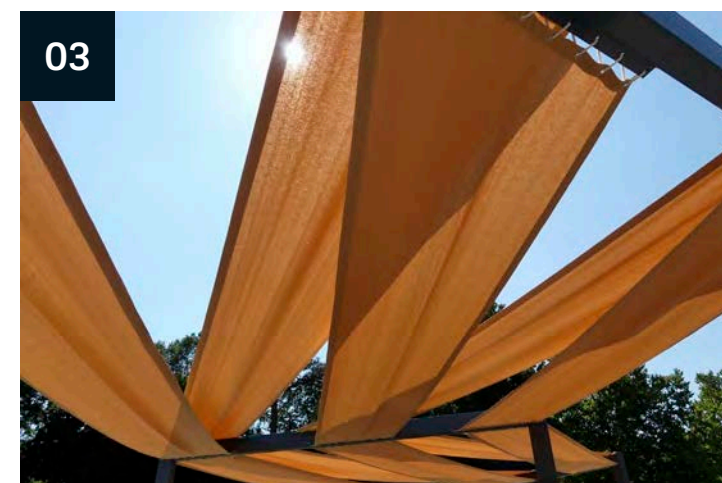

04



Engineered Wood Structures by ICON

ICON offers a full line of traditional and custom wood structures. A variety of standard shelter types and sizes can be fabricated, or a custom structure can be designed to meet the project specification. The framing members are glue-laminated Southern Yellow Pine, and the roof decks are kiln-dried 2x6 Southern Yellow Pine planking. Connection plates are E-coated and powder coated HRF steel, and the fasteners are either galvanized or stainless steel.

Low-Pitch Beam Gables
 Timber Truss Shelters
 Solid Arch Shelters
 Open Arch Shelters
 Post and Beam Shelters
 Amphitheater Shelters
 Enclosed Structures
 Pedestrian Bridges
 Custom structures



Custom Connection Plates

01 WRG30X70TM-P4, Simpsonville, KY, Ref. No. W0014

02 WLP14X20TA-P3-WB-W, McFarland, WI, Ref. No. W0003

03 WRH30X44T-P3, Liverpool, NY, Ref. No. W0012

04 WBS24TM-P6-WB, Bismarck, ND, Ref. No. W0010

05 WDS24X36TM-P64, Sharon, MA, Ref. No. W0035

06 WDS15X20TA-P68, Aurora, IL, Ref. No. W0001

07 WHO46TA-P6, Auburn Hills, MI, Ref. No. W0025

08 WRG30X70TM-P4, Eminence, KY, Ref. No. W0021

09 WRG20X20TA-P3, Urbandale, IA, Ref. No. 4866



01



02



03



04



05



06



07



08



09

EWS Wood Structures

01

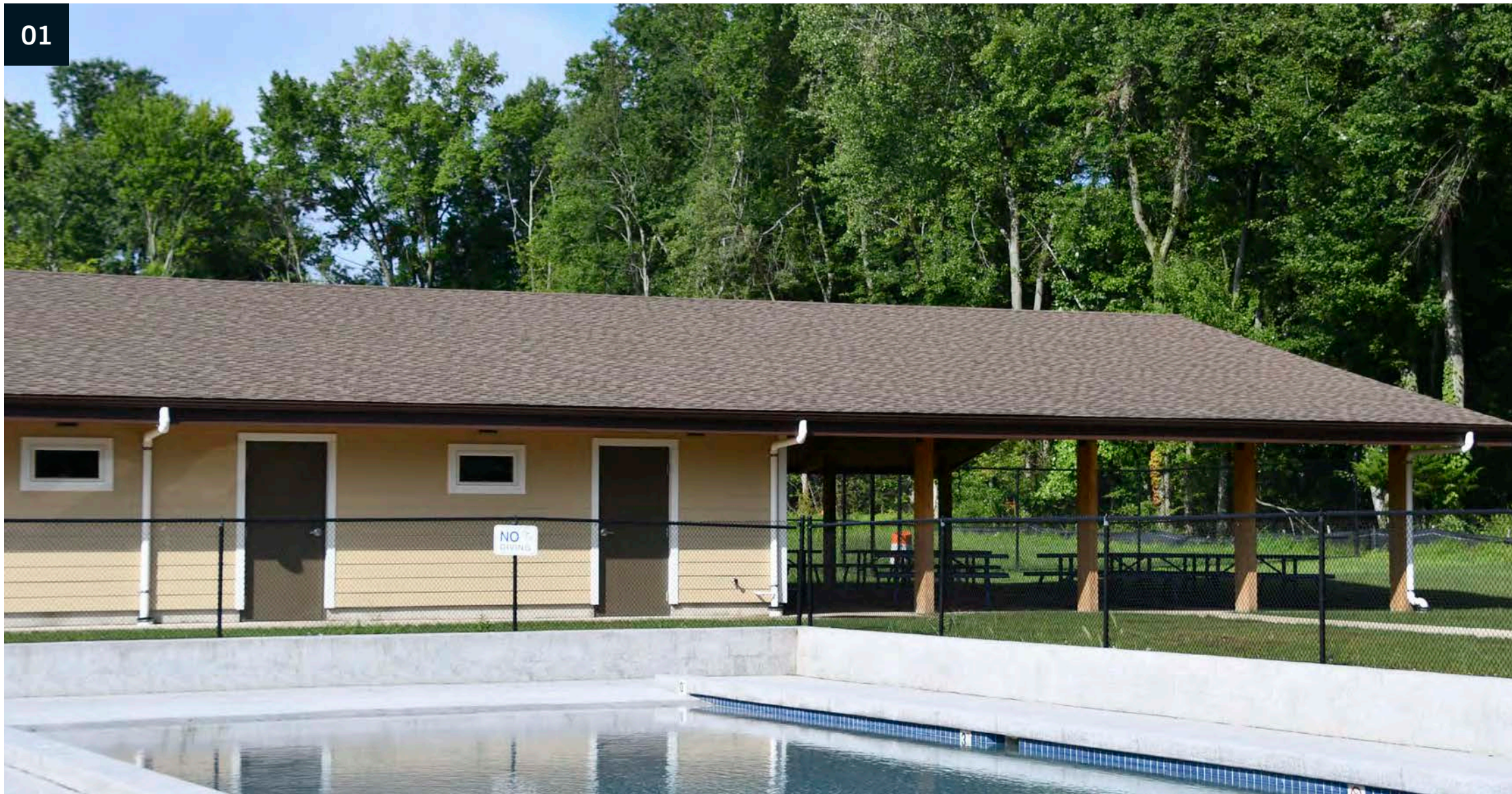

Enclosed Buildings

Walls are laminated Red Cedar milled timbers that screw together much like a conventional milled log home. These timbers are very stable and less likely to twist than the solid white cedar timbers offered by our competitor. Additional materials and fixture packages are available.

- 01 WRG60X132, Hanover, NJ Ref. No. W0013
- 02 Restroom wall construction, Beaufort, SC, Ref. No. W0027
- 03 WTG20X20-10TM-P6, Beaufort, SC, Ref. No. W0027
- 04 Single restroom interior prototype

- Recreation Centers
- Restrooms/Concessions
- Lodges
- Park Activity Buildings
- Golf Course Clubhouses
- Maintenance Buildings
- Storage Buildings
- Warming Huts
- Offices
- Nature Centers
- Campgrounds



02

EWS Wood Structures



03

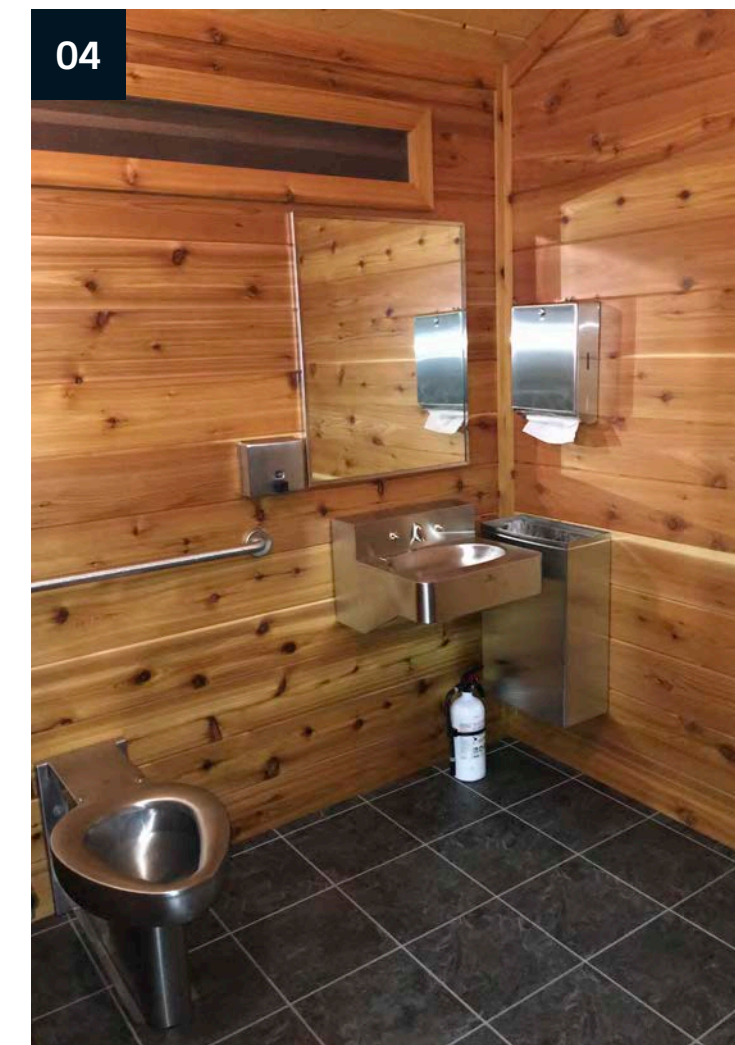

04

Low-Pitch Laminated Curved Beam Shelters

One piece laminated wood beams span from column-to-column. Columns can be treated Southern Yellow Pine (SYP), Alaskan Yellow Cedar or tube steel.

Bay spacings are maximum of 8'-0" O.C., but adjustable for custom sizes and/or roof load requirements. The standard roof pitch is 3/12. Alternate pitches are also available. Eave overhangs are 24" all around the perimeter.

EWS has many standard sizes, but custom sizes are also available upon request. Special pricing may apply.

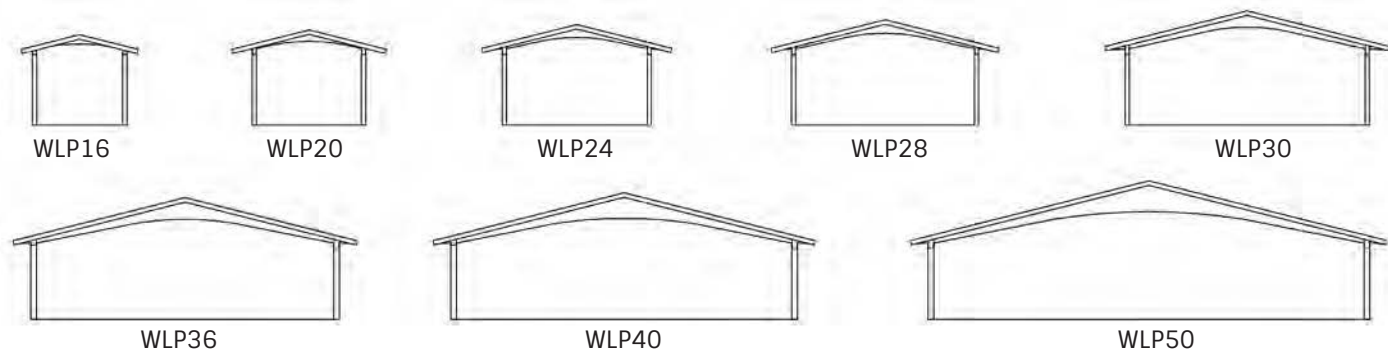

These spans are available in any length, with the maximum bay spacing of 8'. Standard lengths given an 8' bay dimension would be 20', 28', 36', 44', 52', 60', 68', 76', 84', etc. accounting for a 24" roof overhang at the gable ends.

Timber Truss Shelters

Open Timber Truss gabled shelters have heavy laminated beam trusses that are engineered and fabricated at the factory. The dual-pitch version (WPD) has a 4/12 pitch on one side and a 6/12 pitch on the opposite side. The standard Timber Truss Shelter (WTG) has a 4/12 pitch. Both the standard and dual pitch shelters are available in the following sizes:

16X20, 16X28, 20X28, 20X36, 24X28, 24X36, 24X44, 28X36, 28X44, 28X52, 34X44, 34X52, 34X60, 34X76, 44X60



Solid and Open Arch Shelters

Two-piece laminated wood solid arches, and three-piece laminated wood open arches span from column-to-compression ring on the polygonal shelters, and column-to-ridge in rectangular shelters. These Gothic-style arches are used in hexagons, octagons, squares and rectangular shelters.

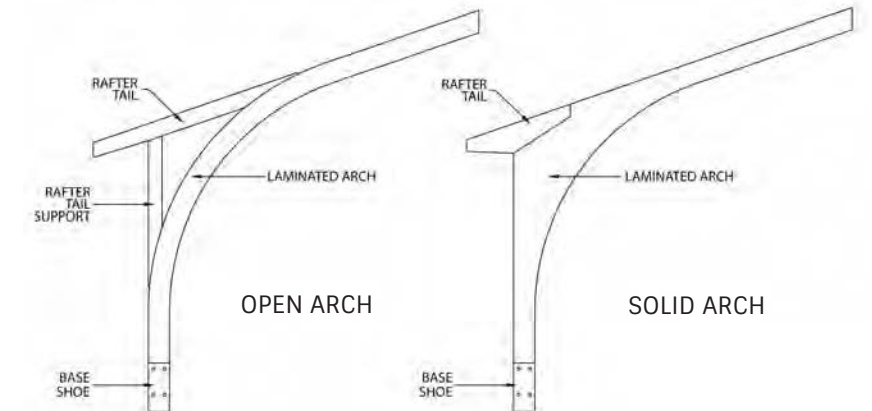

Amphitheater Shelters

Two-piece laminated wood solid arches, and three-piece laminated wood open arches span from column-to-compression ring on the polygonal shelters, and column-to-ridge in rectangular shelters. These Gothic-style arches are used in half-hexagons, half-octagons and tapered rectangular bandshells.

EWS's exclusive wall system, utilizing decorative grade laminated red cedar timbers, can be added for back drops, dressing rooms, and side rooms to use for storage when not in use.



Enclosed Structures

Adding walls to any EWS to enclose or partially enclose a structure can result in a number of building types. Restrooms, concession buildings, cabins, multi-use buildings, visitor centers and nature centers are some of the uses for Engineered Wood Structures with solid wood walls. Restroom plumbing and electrical fixtures are available for all packages, as well as restroom partitions, interior and exterior doors, windows, roll-up concession doors and garage doors.

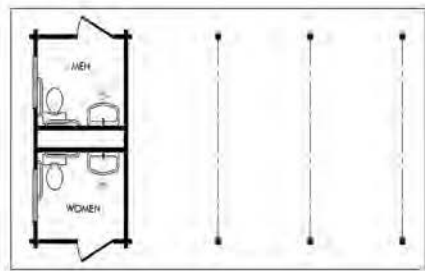

ERG20X36T-P3-W

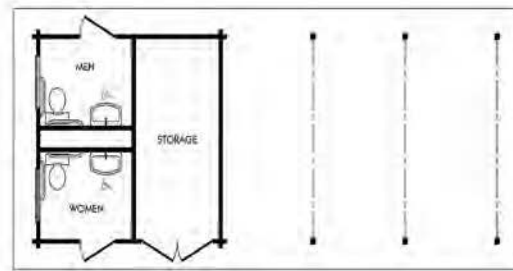

ERG20X44T-P3-W

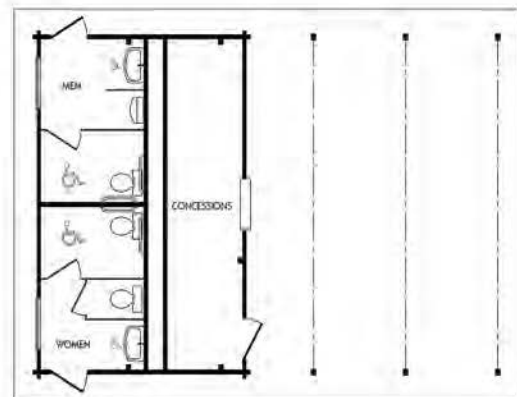

ERG30X44T-P3-W

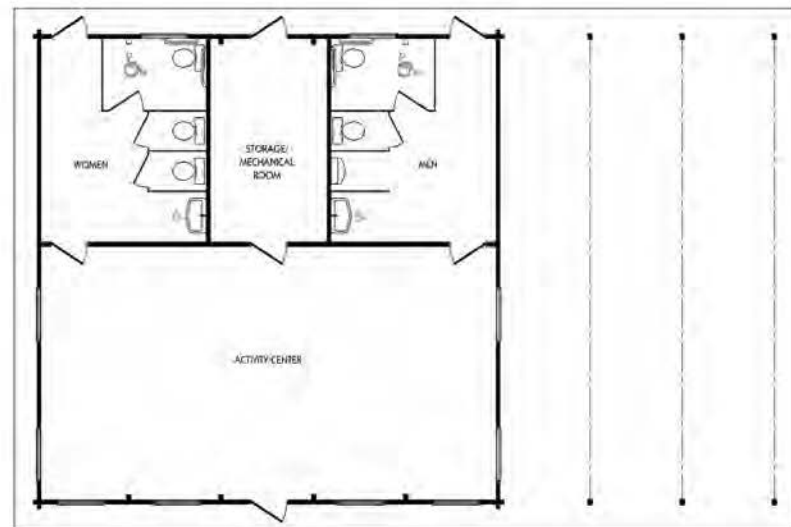

ERG40X68T-P3-W

EWS Wood Structures

Post and Beam Shelters

Squares, Hexagons and Octagons are simply and economically fabricated with architectural grade glue-laminated SYP rafters, purlins and tie beams. Columns can be architectural grade treated glue-laminated SYP, Alaskan Yellow Cedar or e-coated and powder coated steel tube.

Standard roof pitch for hexagons and octagons is 3/12. Standard roof pitch for gables and squares is 4/12. Cupolas, handrails and knee braces can be added at extra cost.

| Squares | Hexagons | Octagons |
|---------|----------|----------|
| WBS16 | WBH16 | WBO20 |
| WBS20 | WBH20 | WBO24 |
| WBS24 | WBH24 | WBO26 |
| WBS30 | WBH30 | WBO30 |
| WBS32 | WBH32 | WBO34 |
| WBS35 | WBH35 | WBO36 |
| WBS36 | WBH36 | WBO40 |
| WBS40 | WBH40 | WBO45 |
| WBS45 | WBH45 | WBO60 |
| WBS50 | WBH50 | |



Pedestrian Bridges

Clear deck widths are available from 4'-6" to 8'-0", and spans from 10' to 80'. All laminated wood components are Southern Yellow Pine. Decking is treated 2x6 Southern Yellow Pine or recycled plastic planks. Connection plates are galvanized HRF and all fasteners are galvanized.

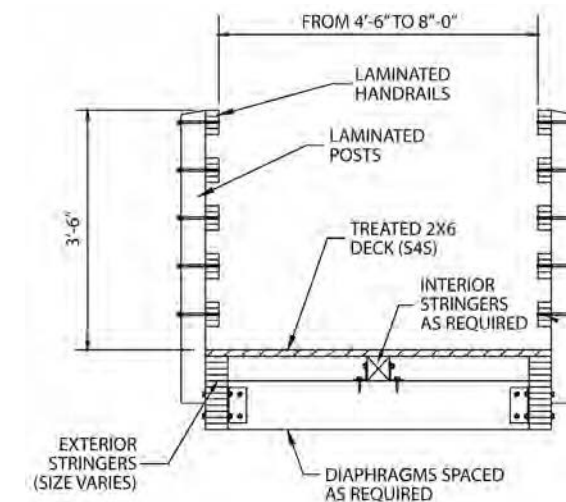

LEED is Leadership in Energy and Environmental Design which is based on requirements developed by the United States Green Building Council (USGBC). The USGBC developed LEED for New Construction, or LEED-NC, with the latest version being LEED v4.1 (BD&C). LEED allocates points on each of their credits; each credit is worth a minimum of 1 point and is always a whole point, no fractions of points. The points are allocated under nine topics.

Location and Transportation (LT) – Credit – Bicycle Facilities, Maximum of 1 Point.
Location of the project such that the functional entry or bicycle storage is within a 200-yard walking distance from a bicycle network.

ICON has bicycle storage facilities and bike rack covers.

Sustainable Sites (SS) – Credit – Heat Island Reduction – Nonroof and Roof, Maximum of 2 Points
Option 1 – Provide shade from structures covered with plant material or solar panels that produce energy. Provide shade from structures that have an aged solar reflectance (SR) of at least 0.28 as measured by ANSI/CRRC S100. If there is no aged SR it must have an initial SR of at least 0.32.

Option 2 – Place a minimum of 75% of parking spaces under cover. Roofing shall have a three-year aged SRI of 0.32 or be a vegetative green roof or be covered by solar panels that produce energy.

ICON has shelters that have metal roofing that meet the initial SR criteria of 0.32. ICON’s LiveS-hade shelters have roofing that is covered with green plants and ICON also has roofing materials with integrated solar panels for energy production.

Energy and Atmosphere (EA) – Credit – Renewable Energy, Maximum of 1 to 5 points.
Use on-site renewable energy systems to offset energy costs. Points based on percentage of total site energy use. From 2% for 1 point to 40% for 5 points.

ICON offers shelters with solar panels that can produce energy.

Materials and Resources (MR) – Credit – Construction and Demolition Waste Management, Maximum of 2 Points.
Reduction of total (construction and demolition) waste material. Must not generate more than 7.5 pounds per sq.ft. of floor area.

ICON’s scrap material from construction as well as the packaging materials can all be recycled and should fit into this restriction.

Materials and Resources (MR) – Credit – Building Product Disclosure and Optimization – Sourcing of Raw Materials, Maximum of 1 Point.

Use products that are sourced from manufacturers that meet one of the responsible sourcing and extraction criteria. One such criteria is Recycled Content.

Most of ICON’s materials are made from steel that uses both pre-consumer and post-consumer recycled content.

Indoor Environmental Quality (EQ) – Prerequisite – Environmental Tobacco Smoke Control, Required
Option 2 – Compartmentalization of Smoking Areas.

ICON can provide smoking shelters for employees to be able to smoke outside in a designated area.

There are minimum characteristics that a project must possess so that it will be eligible for certification under LEED v4.1 (BD&C). ICON suggests that you contact an accredited LEED Professional. ICON does not guarantee any awarded points based on the use of this information.

Picnic Table Capacities

The data given below is an estimate of the number of tables that could fit into the shelters listed. Numbers may vary due to table placement.

| RG & RH | 6' Tables | 8' Tables | SQ | 6' Tables | 8' Tables | HX | 6' Tables | 8' Tables |
|---------|-----------|-----------|----|-----------|-----------|----|-----------|-----------|
| 12x24 | 2 | 2 | 12 | 1 | 1 | 12 | 1 | 1 |
| 12x44 | 5 | 4 | 16 | 4 | 2 | 16 | 2 | 1 |
| 12x64 | 7 | 6 | 20 | 4 | 3 | 20 | 4 | 2 |
| 16x24 | 5 | 3 | 24 | 6 | 4 | 24 | 5 | 3 |
| 16x44 | 8 | 7 | 28 | 8 | 6 | 28 | 7 | 4 |
| 16x64 | 12 | 10 | 30 | 12 | 10 | 30 | 8 | 6 |
| 20x24 | 5 | 4 | 34 | 14 | 12 | 36 | 10 | 8 |
| 20x44 | 9 | 7 | 36 | 16 | 14 | 40 | 14 | 11 |
| 20x64 | 14 | 10 | 40 | 23 | 18 | 44 | 18 | 13 |
| 24x24 | 6 | 5 | 44 | 28 | 22 | 48 | 22 | 17 |
| 24x44 | 13 | 10 | 48 | 32 | 26 | 50 | 24 | 19 |
| 24x64 | 20 | 14 | 50 | 36 | 28 | 56 | 30 | 24 |
| 30x44 | 20 | 15 | 60 | 50 | 41 | 60 | 34 | 25 |
| 30x64 | 28 | 21 | | | | 66 | 42 | 32 |
| 30x84 | 36 | 27 | OC | 6' Tables | 8' Tables | 70 | 46 | 34 |
| 30x104 | 44 | 33 | 16 | 1 | 1 | | | |
| 36x44 | 20 | 13 | 20 | 3 | 2 | | | |
| 36x64 | 28 | 19 | 24 | 4 | 3 | | | |
| 36x84 | 40 | 26 | 28 | 7 | 5 | | | |
| 36x104 | 48 | 32 | 30 | 8 | 6 | | | |
| 40x44 | 20 | 18 | 34 | 9 | 7 | | | |
| 40x64 | 32 | 25 | 36 | 12 | 8 | | | |
| 40x84 | 40 | 36 | 40 | 16 | 10 | | | |
| 40x104 | 48 | 44 | 44 | 18 | 14 | | | |
| 50x64 | 49 | 38 | 48 | 22 | 18 | | | |
| 50x84 | 63 | 49 | 58 | 34 | 26 | | | |
| 50x104 | 77 | 60 | 66 | 42 | 32 | | | |
| 50x124 | 80 | 65 | 72 | 54 | 40 | | | |

ICON Limited Warranty

ICON Shelter Systems, Inc. warrants to the original purchaser of its products that it will provide materials free from manufacturing defects, that will be structurally sound and can be assembled with normal expertise and tools required and practiced in the construction industry. The limited warranty is for a period of ten (10) years from the date of invoice with the following terms and conditions:

1. This warranty is in effect only if the structure has been assembled and installed strictly in accordance with ICON installation drawings and good construction practices, and has been subjected only to normal use and exposure. This warranty is valid only if the structures are maintained according to proper maintenance procedures; have been subjected to only normal use for the purpose for which the goods were designed; have not been subjected to addition or substitution of parts; and have not been modified, altered, or repaired without the approval Icon Shelter Systems approved representatives in any respect which, in the judgment of Icon Shelter Systems, affects the condition or operation of the structures.

2. Abnormal conditions are specifically excluded from coverage under this warranty. This includes but is not limited to the following:
 a. Conditions along or near any body of water containing salt an Ultra Durable Powder coat with E-coat in addition to spark testing is suggested and will be covered under warranty with the exception of sand blast.
 b. Conditions 1500 feet or closer to any body of water containing salt will not have warranty on any metal roof.

3. Contingent liability is specifically excluded. ICON has the option to repair or replace any defect in materials.

4. The owner shall notify ICON to arrange for an inspection within thirty (30) days after discovery of any defect under this warranty, and before any alteration or repair is made or attempted.

5. ICON is in no way responsible for damages caused by others, including: vandalism, fire, lightning or acts of God, corrosion caused by moisture, chemicals, air or salt spray, pollution, or infestation by rodents or other vermin.

6. This limited warranty shall be null and void if the owner or owner's contractor makes any alterations in design or to the structure in the field without prior authorization (this does not mean items such as touch-up paint).

7. ICON shall not be responsible for insurance standards or code compliance changes that may be required in the future.

8. ICON shall not be responsible for delays due to missing, stolen, or non-conforming parts. Any rework of non-conforming parts must be authorized by ICON prior to the time that the rework is done.

9. Some fitting and field cutting of parts could be required and is a normal part of construction, and will not be subject to back charges or cause for rejection.

10. In the unlikely event of any type of failure, ICON reserves the right to alter the design, color, or contributing factors to rectify the condition and help prevent any future reoccurrence(s).

11. ICON specifically excludes any implied warranty of merchantability, of fitness, or of purpose, and there are no warranties, which extend beyond the description of the face hereof.

12. Under no circumstances will ICON be responsible for any consequential or incidental damages due to breach of warranty, and such damages are specifically excluded from this warranty.

13. Pre-finished metal roof surfaces, performance thereof shall be the responsibility of the metal finisher. Warranties to the customer will be handled directly by the metal finisher. ICON assumes or implies no warranties as to finish durability.

14. The structure will require field maintenance in the future to help prevent corrosion. Frequency of field maintenance will depend on (1) the severity of your weather conditions, (2) your storage procedures used before installation, and (3) the care taken by the installer so as to not scrape or scratch finish during installation. ICON Shelter Systems, Inc. assumes no responsibility for the finish and maintenance of finish applied by the contractor in the field.

15. Any Questions? Please call us at (800) 748-0985 or fax us at (616) 396-0944. You may also email us at info@iconshelters.com. Our mailing address is 1455 Lincoln Avenue, Holland, MI 49423.

15. Any Questions? Please call us at (800) 748-0985 or fax us at (616) 396-0944. You may also email us at info@iconshelters.com. Our mailing address is 1455 Lincoln Avenue, Holland, MI 49423.

Craftsman Options

I-Rock GFRC Stone Bases

ICON developed a pre-cast faux stone base to simulate stacked ledgerrock piers. Cast in two sections of glass-fiber reinforced concrete and joined together on-site, I-Rock Bases eliminate the need to have a stone mason custom build piers. See illustration below for installation.



I-Rock Base A-TT



I-Rock A-TT
Raw Sienna, Burnt Sienna & Ochre Ledgerrock Finish

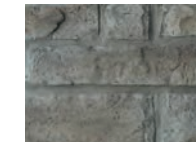

I-Rock B-TT-F
Grey with Red Iron Oxide Ledgerrock Finish



I-Rock C-TT
Raw Umber, Raw Sienna and Grey Ledgerrock Finish

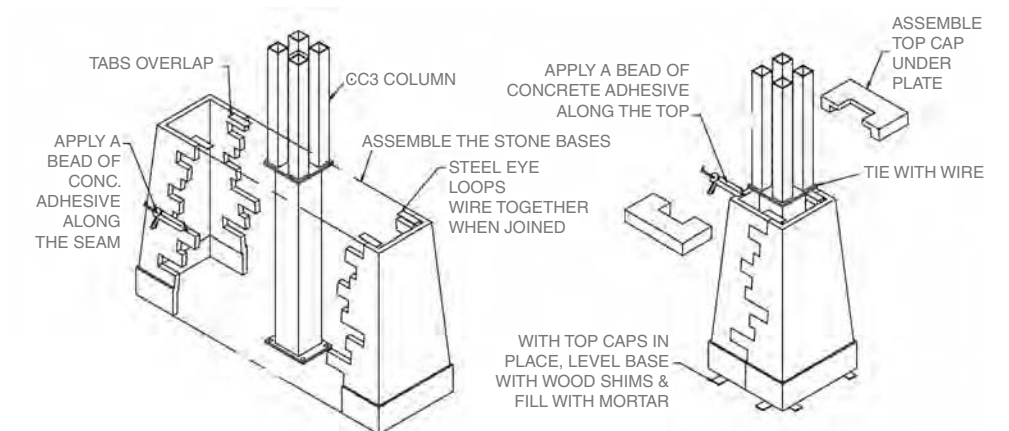

Ornamentation

Craftsman ornamental rails for eaves and clerestory

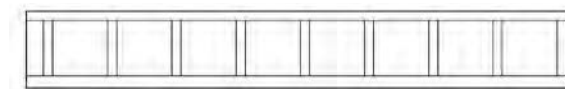

Open Pane Ornament

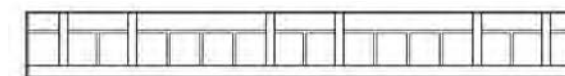

Simulated Leaded Glass Ornament

Peak Treatments

ICON cupolas or a finial peak cap are available to finish the peaks.

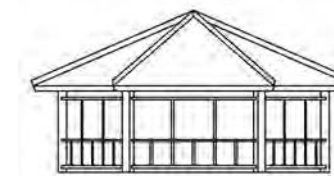

Craftsman Series™ Cupola and Finial Peak Cap

Vented and Clerestory Roofs

Most ICON Industry Standard Shelters are available in multiple roof tier configurations. Two tiers are available on all shelters. Three tiers are available on shelters over 24'. The photos show the difference between the vented roof option and the clerestory roof option. Clerestory offers the room to install ornamental rails or louvered vent closures.



Interior view of vented roof option



Interior view of clerestory roof option

Optional Columns

CC1 through CC4 are optional columns for Craftsman Series™ shelters. CC5 through CC18 can be used on most other structures.

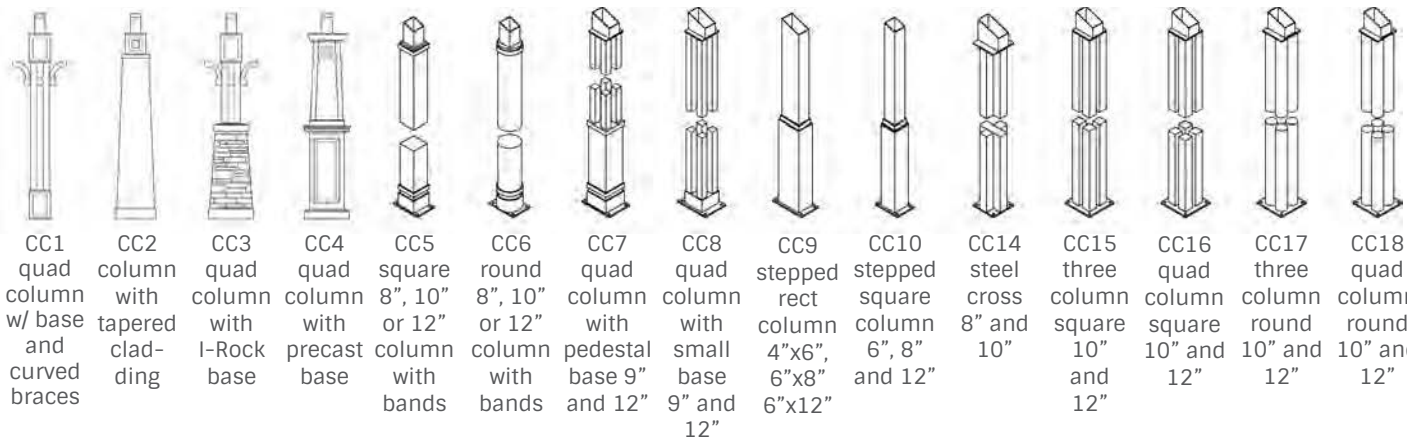

Column-to-Base Connection

Standard base connection with plate 6" below finished concrete



Optional surface mounting with base covers for an added charge



Weathervanes

Standard weathervanes for shelter peaks, ridges and cupolas are shown below. They are available at a modest price. The large weathervane at right is a higher cost item.

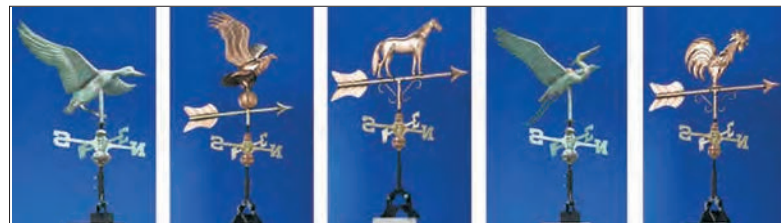

Cupolas

Shown is a broad sampling of cupolas available for many of the ICON shelter models. Custom sizes and styles are available. Cupolas shown for dodecagons are also available in 6 foot diameters.

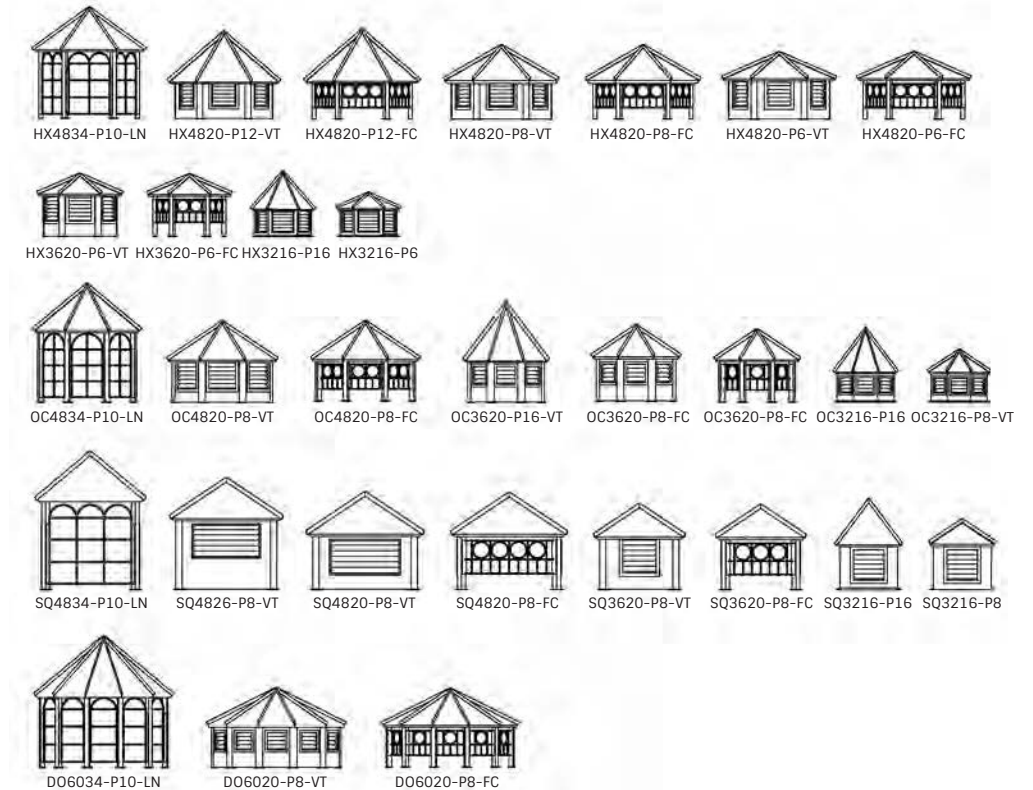

The smaller cupolas are sheet metal only and sit on top of the roofing. The larger cupolas' steel frames bolt to a compression ring.

Handrails and Ornamentation

A variety of ornamental patterns are available for most ICON structures. At right are several standard designs.

ICON has produced a number of different custom railing patterns designed by others for specific projects.

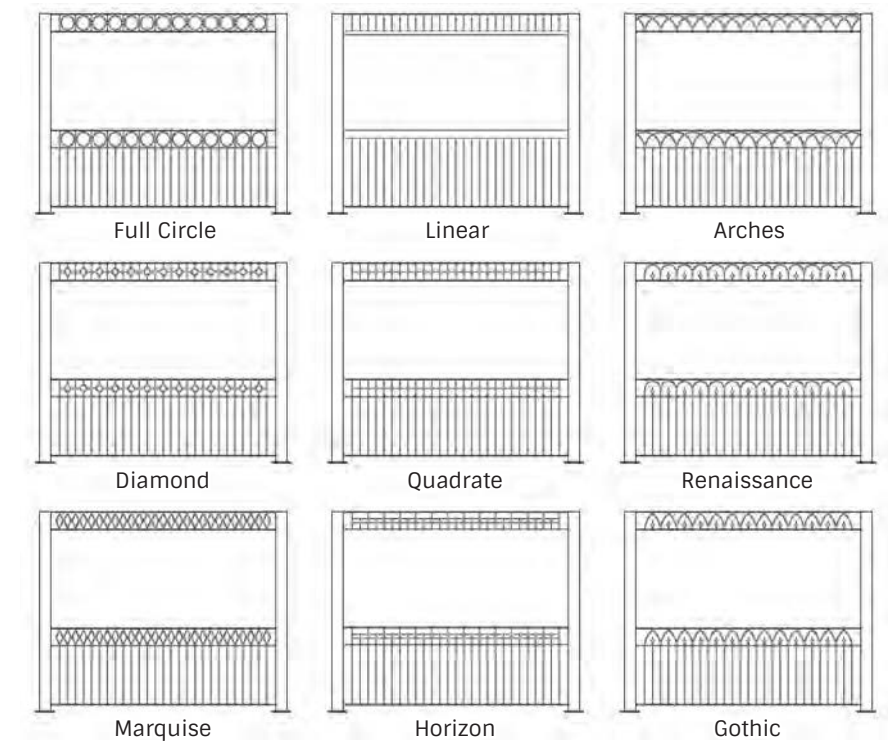

Gable Treatments

Gabled shelters offer the opportunity to mount any number of treatments to customize the structure. Some of what has been done are shown here.



King Post with spire and lower tie beam



Curved tie beam with laser-cut medallion



Rod and clevis ties

Clocks

Clocks are an interesting item to mount on shelters, whether in a cupola or to the shelter frame.

Clock options are shown on page 88.



Clock and curved tie beam



Clock in open steel-framed cupola



Clock on enclosed custom cupola

Emblems and Signs

ICON utilizes the services of a professional sign company to provide signage and other graphic products. These can be found as identifying signs on shelters, entrance arches and other types of structures.



Colored emblem on entry arch



Black-and-white emblem on clock tower



Free-standing 6' diameter sign

Primary Roof Decks for Steel Frame Shelters



24 Ga. Steel Panels

24-gauge galvalume roof panels with a Kynar 500 paint finish. Multi-Rib and Mega-Rib are 36" wide panels that are pre-cut in our factory to fit your shelter. Field adjustment may be necessary for proper fit. Medallion-Lok standing seam roofing is provided uncut to be cut to fit in the field by others. Matching trim in 26 ga. galvalume and fasteners are provided.

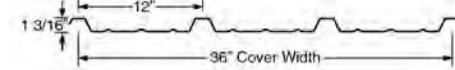

Multi-Rib Panel Profile (M)

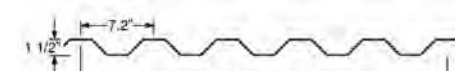

Mega-Rib Panel Profile (G)



Medallion-Lok Standing Seam Profile (S)

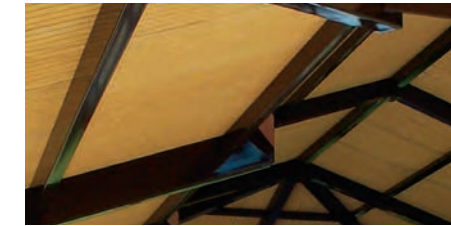

Pre-Cut SIPs

Structural panels (SIPs) are factory-assembled, 4-5/8" thick, laminated and cut to fit on the structure. The composition is 7/16" OSB, 3-1/2" EPS foam core, and a 5/8" skin of T-111 siding.



2x6 Tongue and Groove

The 2x6 tongue and groove wood roof deck is Western Lodgepole Pine, kiln dried, #2 or better, one edge V'd, one edge grooved. Fascia is cedar plank. T&G requires finished roofing materials.

24 Ga. Steel Roof Colors

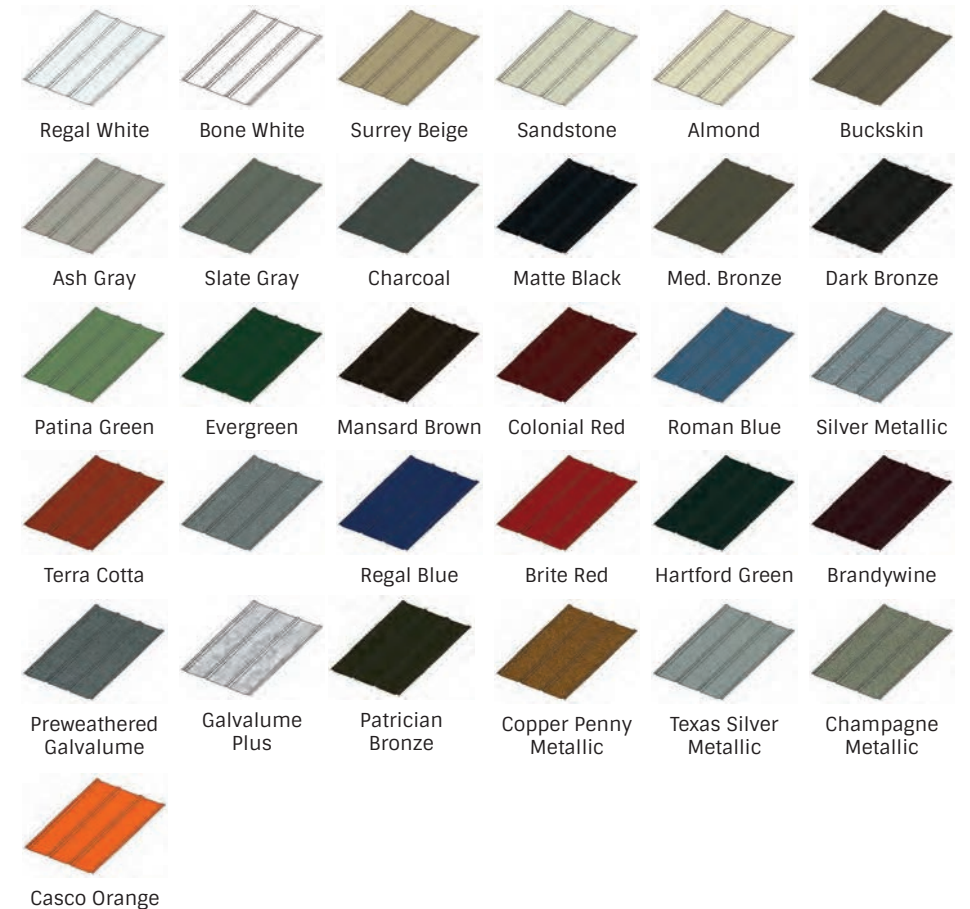

Wood Shelter Frame and Roof Decking Finishing

Wood shelter framing members and T&G wood roof decking can be factory finished in one of the stain colors shown in the chart below. We recommend a high quality stain and sealer with richly pigmented, deep penetrating linseed oil-based stains that provide long lasting beauty and wood protection.

Note: Factory finishing of wood components may increase lead times.



Steel Frame Finishing

The steel framing members can be factory finished in one of three ways: 1) Prime Painted, 2)



Prime Painted

Factory-priming protects the steel components from corrosion throughout the shipping and erection process. The steel is cleaned to remove loose mill scale, loose rust, loose paint, and other loose detrimental foreign matter. The cleaned steel will then be prime painted with quick dry, lead and chromate free alkyd primer. Finish painting in the field is required.

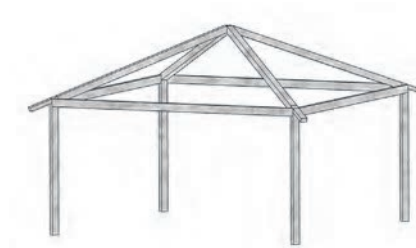

Hot Dipped Galvanized

The hot-dip galvanizing process produces a zinc coating on steel products by immersion of the material in a bath of molten zinc metal. The steel to be coated is first cleaned to remove all oils, greases, soils, mill scale and rust. Because galvanized steel requires no maintenance for decades, its use in public construction is an efficient use of public funds.



E-Coat and Powder Coat

ICON's premier steel coating is a combination of liquid epoxy primer and two coats of TGIC polyester powder coating. The process is:

1. The steel is shot-blasted to the specification of SSPC-SP10 (shot-blasted to near white condition), removing all oil residue, mill scale, weld spatter and slag.
2. The steel is immersed in zinc phosphate in an eight stage pretreatment process.
3. It is immersed in an electrostatically applied liquid epoxy and coated to a uniform 0.7-0.9 mils. This E-coat totally encapsulates the part, preventing rusting.
4. A double coat of TGIC polyester powder is applied, one coat of color and one clear coating for a final finish that is 8-12 mils thick.

Standard Powder Coat Colors

(Actual colors may vary from printed samples)



Premium Powder Coat Colors - Will Incur Additional Costs

These RAL colors have been popular choices as custom frame coatings



2020

ICONOGRAPHY III



Wedding Gazebo
IN20X20M-P12
Greenville, Kentucky
Ref. No. 4025

ICON
Shelter Systems Inc

www.iconsshelters.com
800-748-0985